



## Range of Products & Services

### Product Range

#### Metal Cabinets

- Fire Hose Reel Cabinets
- Fire Extinguisher Cabinets
- Breaching Inlet Cabinets
- Landing Valve Cabinets
- Fuel Oil Filling Cabinets
- Water Fill Cabinets
- File Storage Cabinets
- Control Panels Cabinets
- Equipment/Machine Enclosures
- Computer Server racks

#### Other Products

- Cable Trays & Accessories
- Metal Trays & Bins
- Hollow Metal Steel Doors & Frames
- Sand Trap Louver Doors and Windows
- Work Benches/Desks/Trolleys

### Material of Construction

- Carbon Steel
- Stainless Steel
- Sandwiched (Carbon & Stainless Steel)
- Galvanized Carbon Steel

### Services Offered

#### Design & Drawing

- Architectural Design
- Drawing Preparation
- Preparation of Cutting Layout

#### Metal Forming

- Cutting of Metal Sheet
- Pressing
- Bending
- Punching

#### Fabrication & Welding

- Steel Fabrication
- Welding
- Assembly & Fitting

#### Metal Coating & Surface Finishing

- Powder Coating
- Mirror Buff Finishing
- Brush Finish

WeldCut Middle East is manufacturer and distributor wide range of sheet metal fabricated items for the various sectors of industry. WME keeps itself at forefront by providing best design & drawing services using latest software, the products are manufactured using a high grade steel material, the fabrication & assembly of the products is done by skilled workers. The product undergoes a quality inspection procedure to ensure uniform product quality.

At WME have a wide range of products which are either a standard model as per industry or tailor made to suit your specific project requirements. Our experienced sales staff will support you to advise the best practices in the industry as well as options available to comply with national and international codes and regulations.

WME is very well suited and established its role as an OEM supplier to many of the product brands/industries. Hence WME is quite flexible to work with brands as well as end user without compromise to quality, maintaining best commercial pricing at all the times. Our products are well accepted in geographically, especially in the Middle East region. WME is proud to pronounce that we are part of various prestigious projects in UAE, Qatar, Oman, Bahrain & Saudi Arabia.

WME is committed to providing the highest level of customer service and support. Our support to our clients is all round, starts from inquiry level till the installation at site. This makes us a supplier of choice.

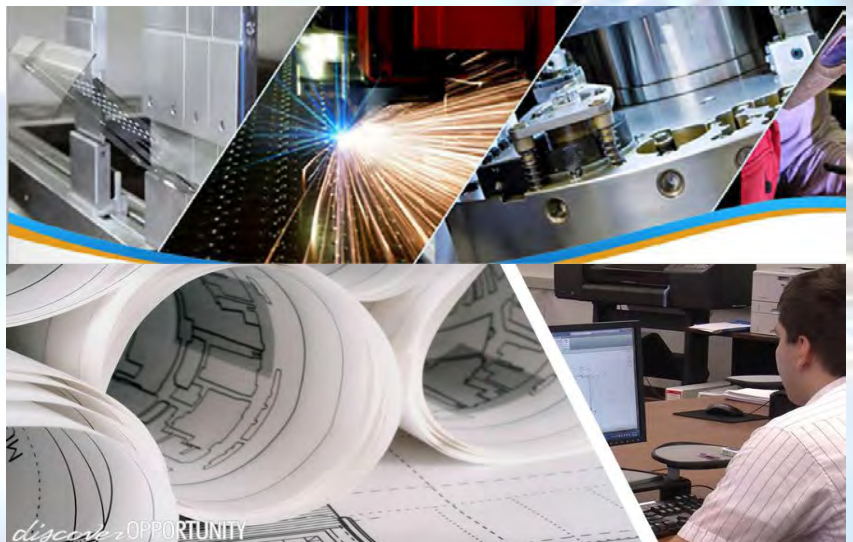

# Fire Fighting Cabinets

WME is a supplier of various types and wide range of metal cabinets for Fire Fighting Industry. The range of products we cover are listed as under,

- Fire Hose Reel Cabinets
- Fire Extinguisher Cabinets
- Breaching Inlet Cabinets
- Landing Valve Cabinets

## Basic Options Available

Material: Stainless Steel/ Electro Galvanized Steel/ Carbon Steel

Sheet Thickness: 1.2 / 1.5/ 2.0 mm

Installations: Recessed with wall Surface / Wall Mounted

Finish: Mirror Finish/Brush Finish/Powder Coated

Cabinet Dimension: To suit the internals of cabinet, custom made

## Further Options

Finish: Decorative Islamic Door Design

Protection: Weather Proof Design/ Non-Weather Proof

Door Type: Plain Door/Door with see-through window

Number of Doors: Single Door/ Double Door

Window Type: Wire Mesh Glass/Clear Glass/Clear Polycarbonate

Door Opening: Sideways, Top Side (provided with gas struts)

Locking: Stainless Steel Round Lock/ Lock with keys

Hinges: Piano Hinges, Concealed Hinges

Other: Magnetic Catch Lock

Color/ Finish: Red, White, Brown, any color of choice

Material: Full Stainless, Full Carbon Steel, Door SS & Box Carbon Steel



# Water & Fuel Oil Filling Cabinet

Water & Fuel Fill Cabinets are required when Water/fuel tank are located away to a remote distance or locations such as ground floor or basement. In such situation fuel fill cabinets are ideal since these cabinets are packed with features allowing safe and easy filling of tanks.

WeldCut Middle East fabricates fill cabinets to industry standard and as per site requirement. Some details about the fill cabinets are as given below.

## Type of fill Cabinets

- Type A : Cabinet for Single Fill Valve
- Type B : Cabinet for Two Fill Valves
- Type C : Cabinet for Three Fill Valves

## Material of Construction

- Carbon Steel (Painted or Powder Coated)
- Stainless Steel 304
- Stainless Steel 316

## Mounting Type

- Wall Mounted
- Recessed Type/Flushed with wall surface

## Standard Features

- View Window/See through Window
- Piano Hinges
- Door stopper
- Door Lock
- Water resistant Door

## Optional Features/ Extras

- Finish: Mirror Finish/Brush Finish/Powder Coated(color)
- Color/ Finish: Red, White, Brown, any color of choice
- Lighting & Switching Assembly
- Fill Valve Assembly
- Non Return Valves
- Water/ Fuel Contents Gauge
- Capacitance Level Controls
- High Level Alarm Panel
- Gas Strut for Holding Door in position





# Control Panels, File Cabinet & Enclosures

At WeldCut Middle East we extend our services to other industries providing the spectrum of custom made products. Our expert design team supports you with understanding and designing the products to best suit your application. Our experts provide you support from conceptual design till the fabrication & site installation, thus providing end to end services.

We focus at providing better design & best possible commercial pricing along with delivery time. Our Major products to some industries are listed as under

- File Storage Cabinets
- Control Panels Cabinets
- Equipment/Machine Enclosures
- Computer Server Racks

## Basic Options Available

Material: Stainless Steel/ Electro Galvanized Steel/ Carbon Steel

Sheet Thickness: 1.2 / 1.5/ 2.0 mm

Finish: Mirror Finish/Brush Finish/Powder Coated

Dimension: To suit the internals of cabinet, custom made

## Further Options

Finish: Decorative Islamic Door Design

Protection: Weather Proof Design/ Non-Weather Proof

Door Type: Plain Door/Door with see-through window

Number of Doors: Single Door/ Double Door

Window Type: Wire Mesh Glass/Clear Glass/Clear Polycarbonate

Door Opening: Sideways, Top Side (provided with gas struts)

Locking: Stainless Steel Round Lock/ Lock with keys

Hinges: Piano Hinges, Concealed Hinges

Other: Magnetic Catch Lock

Color/ Finish: Red, White, Brown, any color of choice



# Cable Trays & Accessories

WeldCut Middle East cable trays are designed as a complete system with simple accessories. Integral connectors are included for bends tees etc. for all cable tray ranges.

The complete system is available from 12mm - 50mm deep and all ranges have the same plan footprint that facilitates the set out of cable runs prior to finalization of design. Our standard Supply included following forms of cable tray elements.

## **Straight Cable Tray Lengths** (3.0m length) available as

- Light Duty (12mm side Height)
- Medium Duty (25mm side Height)
- Heavy Duty (50mm side Height)

## **Flat Bends**

- 45° Bend
- 90° Bend
- Adjustable Flat Bends

## **Tees & Crossovers**

- Horizontal & Vertical Equal Tee
- Unequal tees
- Crossovers
- Y Patterns

## **Reducers**

- Straight Reducer
- Right Reducer
- Left Reducer

## **Risers**

- 90° Internal
- 90° External
- flexible risers

## **Cable Tray Covers**

A complete range of closed & ventilated covers for cable tray system

## **Accessories**

- Flat Plate Coupler
- Bend Coupler
- Wrap Coupler
- Horizontal Coupler
- Vertical Coupler
- U Coupler
- Drop Out
- Fish Plate
- Cantilever Bracket
- Fastener

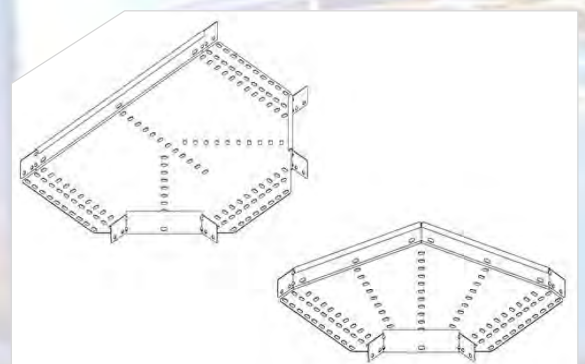
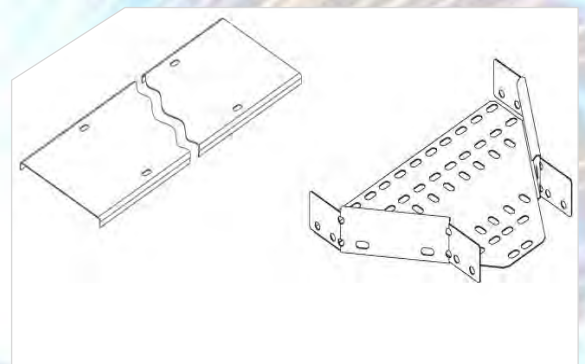
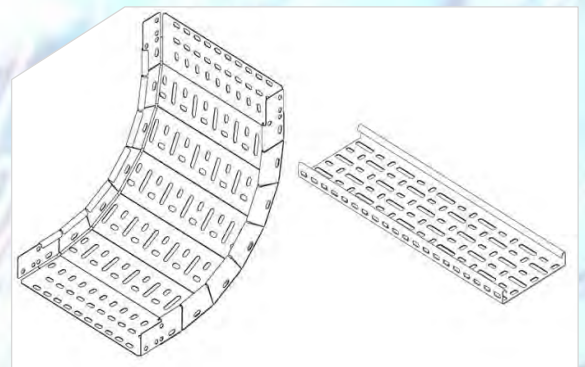

## Basic Options Available

**Material:** Stainless Steel/ Electro Galvanized Steel/ hot Dip Galvanized Steel/ Pre-Galvanized Steel /Powder Coated/ Aluminium

**Sheet Thickness:** 1.0/ 1.5/ 2.0 mm (for other thicknesses please contact sales department)

**Cable Tray Width:** 50mm, 100mm, 150mm, 200mm, 300mm, 450mm, 600mm

**Cable Tray Height:** the cable tray heights are as per type of duty; however we can supply the cable tray made to suit your specific requirement/project. Kindly contact sales department.

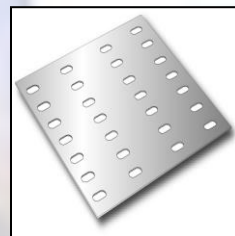
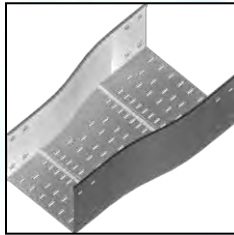
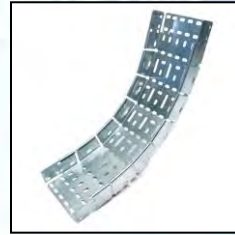
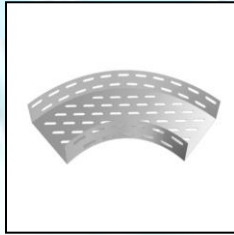
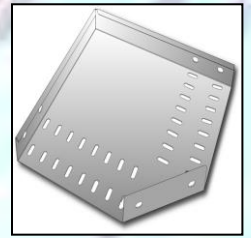
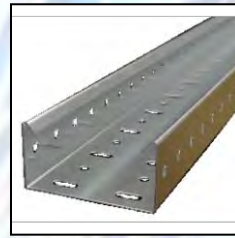
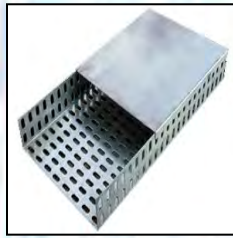
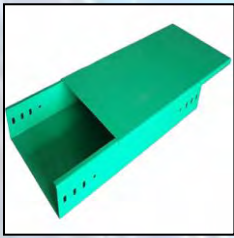

# Trays, Doors, Desks, Sand Traps

At WeldCut Middle East we cater to various other industries requirement in sheet metal work which includes

- Food Industry
- Goods Warehouses
- Diesel Power Generation
- Construction Industry
- Electrical Switchgear & Components Industry
- Workshop & Office Furniture

We supply various components and complete fabricated sheet metal products as per client design and requirement. All our products are made to suite the requirement of application. The various products fabricated and supplied are.

- Metal Trays & Bins
- Metal Open Shelves
- Hollow Metal Steel Doors & Frames
- Sand Trap Louver Doors and Windows
- Work Benches/Desks
- Workshop Trolleys
- Electrical Back Boxes

## Basic Options Available

Material: Stainless Steel/ Electro Galvanized Steel/ Carbon Steel

Sheet Thickness: 1.2 / 1.5/ 2.0 mm

Finish: Mirror Finish/Brush Finish/Powder Coated

Dimension: Custom Made

